

POTTERTON



Titanium and Gold Range guide



part of **BAXI**



150 years of British-built brilliance

If you want to know what makes Potterton different, this fact should illustrate it perfectly; for more than 150 years, we've manufactured more than seven million boilers right across Great Britain.

All Potterton boilers are backed by our award-winning customer support service, for your complete peace of mind.

Market-leading specification at a game-changing price.

Before any boiler leaves our factory, it must achieve a 100% pass rate throughout our rigorous testing programme. This provides confidence that all Potterton boilers will meet A-rated performance, reliability and high-efficiency.

Total peace of mind with parts and labour warranties.

We're so confident of the quality of our boilers that we're now offering a seven year parts and labour warranty for the Potterton Titanium range*. The Potterton Gold has a two year parts and labour warranty as standard.*

The best support service in the business.

It's not just our boilers that are the best you can get. Our support service is too, Baxi Customer Support offers award winning customer service from our UK contact centre and hundreds of our own highly trained Gas Safe registered engineers across the UK, so we are here to help, if you need us.

Potterton – totally dependable.

*Terms and conditions apply. Visit www.potterton.co.uk/warranty for more details.

Why choose Potterton?

Whichever boiler you choose, you can depend on Potterton.

Reliability

Every boiler is tested using gas, electricity and water before it leaves the production line. If it doesn't get 100%, it doesn't pass.

Energy efficiency

All Potterton boilers are extremely energy efficient and are Energy Saving Trust Endorsed, so they are economical to run and kind to the environment.

Engineering quality

Potterton boilers are manufactured in the UK, using tried and tested technology and genuine, approved components.

Easy to install

Wall mounting plates, 1.3 metre lead** and flexible flue options save valuable time during installation.

**Only on the Combi and System. 1 metre on Titanium Heat.



Potterton Titanium Combi

Efficient, flexible and easy to install the Potterton Titanium Combi gives complete peace of mind.

Available in 24kW, 28kW, 33kW and 40kW outputs

Energy Saving Trust Endorsed

Flue lengths of up to 20m for flexibility of siting



**Flexible
siting
options**

**Range of
outputs**

**Energy
Saving
Trust
Endorsed**

Efficient

The Potterton Titanium Combi boiler delivers instant hot water and heating, extremely efficiently. It is fully modulating, regulating output to suit demand, making it very cost effective to run.

A seven year parts and labour warranty* gives complete peace of mind for both installer and householder.

Feature	Benefits
Outputs of 24kW, 28kW, 33kW and 40kW	A model for every size of home
24 hour mechanical clock and filling loop supplied as standard	Saves time during installation
Wall mounting plate	For easier installation
Extensive flue options up to 20 metres	Makes it easier to site the boiler
Energy Saving Trust Endorsed	Meets the strictest product and energy performance criteria, and is extremely energy efficient and cost effective
7 year warranty*	For complete peace of mind

*Subject to registration and an annual service. Terms and conditions apply. Visit www.potterton.co.uk/warranty for more details.

Technical information

The Potterton Titanium Combi is compatible with Flue Group A, G and N

Potterton Titanium Combi	24kW	28kW	33kW	40kW
Sales code	7219493	7219494	7219495	7219496
Controls				
Concealed user controls	✓	✓	✓	✓
On/off switch with reset	✓	✓	✓	✓
User adjustable DHW temperature	✓	✓	✓	✓
User adjustable CH temperature	✓	✓	✓	✓
LED temp/status/fault diagnosis display	2 digits/3 LEDs	2 digits/3 LEDs	2 digits/3 LEDs	2 digits/3 LEDs
Integral 24hr electro-mechanical timer	✓	✓	✓	✓
Gas				
Gas supply pipe size	mm	22	22	22
Natural gas	✓	✓	✓	✓
Nominal inlet supply pressure	mbar	20	20	20
Maximum gas rate	m ³ hr	2.61	3.1	3.6
Heat Input Central Heating (CH)	kW Max Gross(QnHs)	22.7	27.4	32.1
	kW Min Gross(QnHs)	7.8	10	10.8
Heat Output CH non condensing	kW Max (Pn)	20	24	28
	kW min (Pn)	6.8	8.7	9.4
Heat Output CH condensing	kW max (Pnc)	21	25.9	30.3
	kW min (Pnc)	7.4	9.5	10.2
Heat Input Domestic Hot Water	kW Max Gross (QnWHS)	27.4	32.1	37.7
Heat Output Domestic Hot Water	kW Max (Pn)	24	28	33
Maximum domestic hot water flow rate	l/min @ 35°C rise	9.8	11.5	13.5
SAP 2009 Annual Efficiency (PCDB/SEDBUK)	%	88.6	88.6	88.5
NOx Class		5	5	5
ErP Product Information				
NOx	mg/kWh	20	23	20
Sound Power Level, Indoors	LWA dB	50	53	52
Space Heating Efficiency Class		A	A	A
Water Heating Declared Load Profile		XL	XL	XL
Water Heating Efficiency Class		A	A	A
Electrical				
Electrical supply	Volts/Hz	230/50	230/50	230/50
Permanent live required		✓	✓	✓
Power consumption	watts	85	120	125
External fuse rating	amps	3	3	3
Internal fuse rating		F2L	F2L	F2L
Ingress protection rating		IPX 5D	IPX 5D	IPX 5D
24 hour pump exercise		✓	✓	✓
Pump overrun		✓	✓	✓
Integral 'boiler only' frost thermostat		✓	✓	✓
Mechanical and hydraulic				
Compartment ventilation requirement		None	None	None
Pre-plumbing/wall mounting jig		✓	✓	✓
Flow and return pipe size	mm	22	22	22
Condensate discharge pipe size	mm	21.5	21.5	21.5
Integral automatic bypass		✓	✓	✓
Min domestic hot water flow rate	l/min	2	2	2
Min domestic hot water operating pressure	bar	0.15	0.15	0.15
Maximum DHW system pressure	bar	8	8	8
Safety discharge pressure	bar	3	3	3
Integral expansion vessel capacity	litres	8	8	8
Max capacity of central heating system	litres	125	125	125
Temporary filling loop included		✓	✓	✓
CH system inhibitor required		✓	✓	✓
Concentric flue systems				
Standard horizontal flue kit length	mm	685	685	685
Max equiv length horizontal/vertical (60/100mm)	m	10	10	10
Max equiv length horizontal/vertical (80/125mm)	m	20	20	20
Equivalent length per 135° bend	m	0.5	0.5	0.5
Equivalent length per 93° bend	m	1	1	1
Twin flue system				
Diameters	mm	80/80	80/80	80/80
Max equiv length horizontal/vertical (parallel pipes)	m	15/15	15/15	15/15
Equivalent length per 135° bend	m	0.25	0.25	0.25
Equivalent length per 91.5° Bend	m	0.5	0.5	0.5
Weights				
Max installation lift weight	kg	40.2	40.2	41.7
Gross packaged boiler weight	kg	46	46	47.5

Technical specification



Dimensions

A width	450mm
B height	780mm
C depth	345mm

Service clearances

D side	5mm
E upper	175mm min
F lower	150mm min
G front	5mm min in operation 450mm for servicing

NB flue is offset to the right

24 hour
timer as
standard

Pre-
plumbing
jig

Extensive
flue
options

7
YEAR
WARRANTY

Inside the boiler

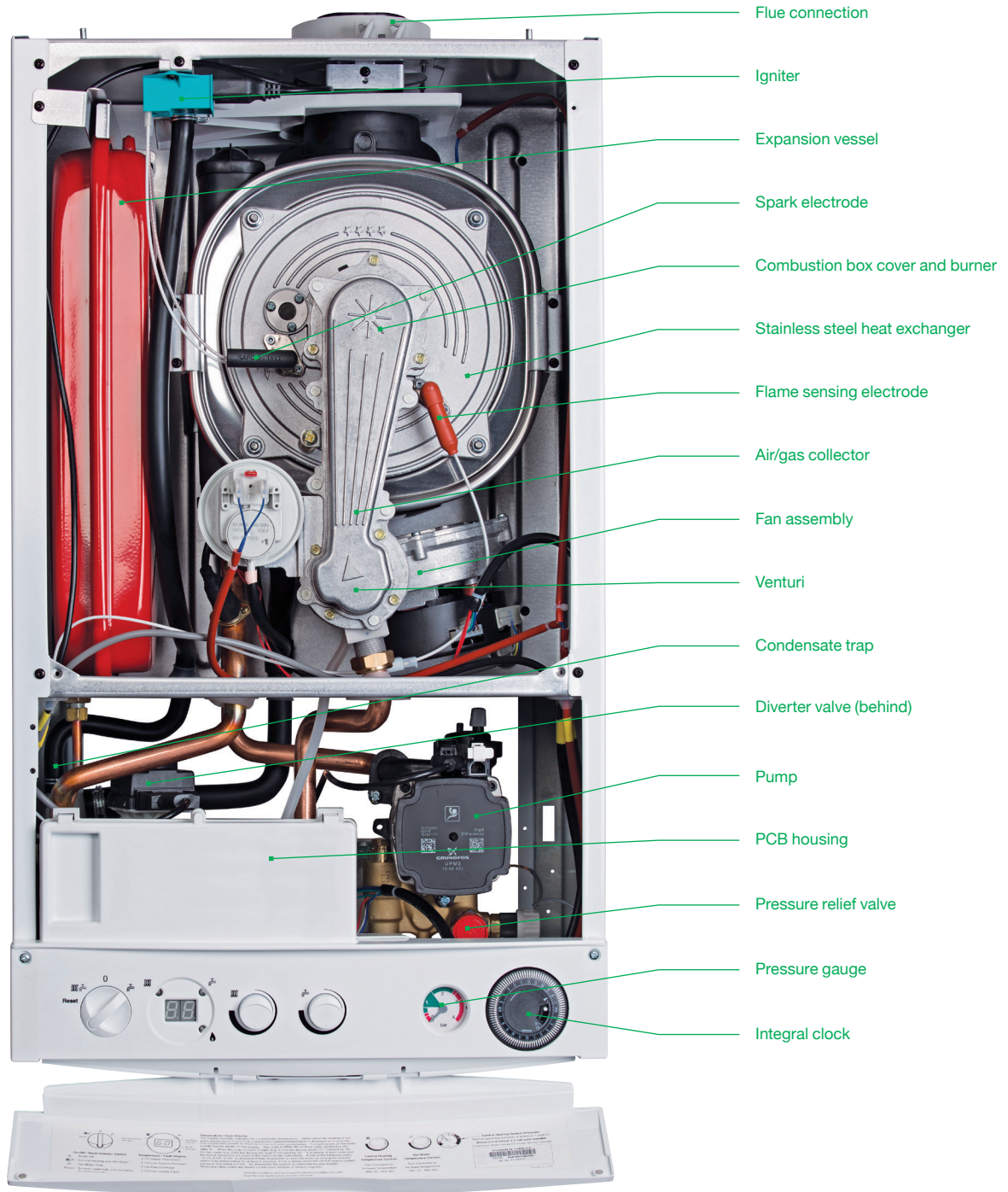

Flues

These are the flues most frequently installed with the Potterton Titanium Combi ErP.
For the full range, see pages 28-31.

Horizontal concentric flues Ø 60/100mm

MULTIFIT FLUE GROUP A

Item	Description (multifit) flue system	Colour	Specification	Key and OD dimensions	Sales code
4	Standard horizontal flue inc. low profile elbow and fixing screws*	White pipe/ black terminal	685mm	100mm	7222019
8	1m flue extension inc. fixing screws	White	1000mm	100mm	720648801
11	93° flue bend inc. fixing screws	White	93°	100mm	720648401
13	135° flue bend inc. fixing screws (pair)	White	135°	100mm	720647901

Vertical concentric flues Ø 60/100mm

MULTIFIT FLUE GROUP A

Note - this flue group is ONLY suitable for combi and system appliances

Item	Description (multifit) flue system	Colour	Specification	Key and OD dimensions	Sales code
27	Vertical flue terminal	Black		100mm	5118576
8	1m flue extension inc. fixing screws	White	1000mm	100mm	720648801
11	93° flue bend inc. fixing screws	White	93°	100mm	720648401
13	135° flue bend (pair) inc. fixing screws	White	135°	100mm	720647901
29	Pitched roof flashing		25°/50°	125mm	5122151
30	Flat roof flashing			125mm	246144

Plume displacement kits Ø 60/100mm

MULTIFIT FLUE GROUP A

Item	Description (multifit) flue system	Colour	Specification	Key and OD dimensions	Sales code
16	Plume displacement terminal kit inc. 1m extension and brackets**	White		60mm	720627001
17	Plume displacement kit extension and brackets	White	1000mm	60mm	720643401
18	Plume displacement kit bend	White	93°	60mm	5121369
19	Plume displacement kit bend – pair	White	135°	60mm	5121370
	Plume displacement terminal guard (not shown)	Stainless Steel	100mm	60mm	720644601

*Not compatible with items 16 and 20. **Compatible with item 1.



Potterton Gold Combi

Reliable construction and high efficiency make this a great, dependable boiler.

Available in 24kW, 28kW and 33kW outputs

Pre-plumbing jig

Flue lengths of up to 20m for flexibility of siting



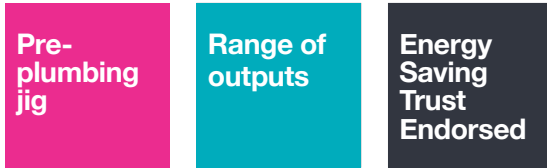

Reliable

The Potterton Gold Combi combines long term reliability and ease of installation with high efficiency and ultra-low emissions.

A two year parts and labour warranty* gives complete peace of mind for both installer and householder.

Feature	Benefits
Outputs of 24kW, 28kW and 33kW	Suitable for most sizes of home
Fully modulating	Adapts output to suit demand, making it extremely cost efficient to run
Flue lengths up to 20 metres	For great siting flexibility
24 hour mechanical clock and filling loop supplied as standard	For maximum comfort and energy efficiency
Pre-plumbing jig	For easy installation; allows first fix of system pipework, before the boiler is installed
2 year parts and labour warranty*	For complete peace of mind
Energy Saving Trust Endorsed	Meets the strictest product and energy performance criteria, and is extremely energy efficient and cost effective

*Subject to registration and an annual service. Terms and conditions apply. Visit www.potterton.co.uk/warranty for more details.

Technical information

The Potterton Gold Combi is compatible with Flue Group A, G and N

Potterton Gold Combi		24kW	28kW	33kW	28kW LPG
Sales code		7219427	7219428	7219429	7219430
Controls					
Concealed user controls		✓	✓	✓	✓
On/off switch with reset		✓	✓	✓	✓
User adjustable DHW temperature		✓	✓	✓	✓
User adjustable CH temperature		✓	✓	✓	✓
LED temp/status/fault diagnosis display		2 digits/3 LEDs	2 digits/3 LEDs	2 digits/3 LEDs	2 digits/3 LEDs
Integral 24hr electro-mechanical timer		✓	✓	✓	✓
Gas					
Gas supply pipe size	mm	22	22	22	22
Natural gas		✓	✓	✓	N/A
LPG (propane)		N/A	N/A	N/A	✓
Nominal inlet supply pressure NG	mbar	20	20	20	N/A
Nominal inlet supply pressure LPG	mbar	N/A	N/A	N/A	37
Maximum gas rate	m ³ /hr	2.61	3.1	3.6	2.25 kg/hr
Heat Input Central Heating (CH)	kW Max Gross(QnHs)	22.7	27.4	32.1	27.4
	kW Min Gross(QnHs)	7.8	10	10.8	10
Heat Output CH non condensing	kW Max (Pn)	20	24	28	24
	kW min (Pn)	6.8	8.7	9.4	8.7
Heat Output CH condensing	kW max (Pnc)	21	25.9	30.3	25.9
	kW min (Pnc)	7.4	9.5	10.2	9.5
Heat Input Domestic Hot Water	kW Max Gross (QnHs)	27.4	32.1	37.7	32.1
Heat Output Domestic Hot Water	kW Max (Pn)	24	28	33	28
Maximum domestic hot water flow rate	l/min @ 35°C rise	9.8	11.5	13.5	11.5
SAP 2009 Annual Efficiency (PCDB/SEDBUK)	%	88.6	88.6	88.5	90.6
NOx Class		5	5	5	5
ErP Product Information					
NOx	mg/kWh	20	23	20	23
Sound Power Level, Indoors	LWA dB	50	53	52	53
Space Heating Efficiency Class		A	A	A	A
Water Heating Declared Load Profile		XL	XL	XL	XL
Water Heating Efficiency Class		A	A	A	A
Electrical					
Electrical supply	Volts/Hz	230/50	230/50	230/50	230/50
Permanent live required		✓	✓	✓	✓
Power consumption	watts	85	120	125	120
External fuse rating	amps	3	3	3	3
Internal fuse rating		F2L	F2L	F2L	F2L
Ingress protection rating (without electro-mechanical timer fitted)		IPX 5D	IPX 5D	IPX 5D	IPX 5D
24 hour pump exercise		✓	✓	✓	✓
Pump overrun		✓	✓	✓	✓
Integral 'boiler only' frost thermostat		✓	✓	✓	✓
Mechanical and hydraulic					
Compartment ventilation requirement		None	None	None	None
Pre-plumbing/wall mounting jig		✓	✓	✓	✓
Flow and return pipe size	mm	22	22	22	22
Condensate discharge pipe size	mm	21.5	21.5	21.5	21.5
Integral automatic bypass		✓	✓	✓	✓
Min domestic hot water flow rate	l/min	2	2	2	2
Min domestic hot water operating pressure	bar	0.15	0.15	0.15	0.15
Maximum DHW system pressure	bar	8	8	8	8
Safety discharge pressure	bar	3	3	3	3
Integral expansion vessel capacity	litres	8	8	8	8
Max capacity of central heating system	litres	125	125	125	125
CH system inhibitor required		✓	✓	✓	✓
Concentric flue systems					
Standard horizontal flue kit length	mm	685	685	685	685
Max equiv length horizontal/vertical (60/100mm)	m	10	10	10	10
Max equiv length horizontal/vertical (80/125mm)	m	20	20	20	20
Equivalent length per 135° bend	m	0.5	0.5	0.5	0.5
Equivalent length per 93° bend	m	1	1	1	1
Twin flue system					
Diameters	mm	80/80	80/80	80/80	80/80
Max equiv length horizontal/vertical (parallel pipes)	m	15/15	15/15	15/15	15/15
Equivalent length per 135° bend	m	0.25	0.25	0.25	0.25
Equivalent length per 91.5° Bend	m	0.5	0.5	0.5	0.5
Weights					
Max installation lift weight	kg	40.2	40.2	41.7	40.2
Gross packaged boiler weight	kg	46	46	47.5	46

Technical specification



Dimensions

A width	450mm
B height	780mm
C depth	345mm

Service clearances

D side	5mm
E upper	175mm min
F lower	150mm min
G front	5mm min in operation 450mm for servicing

NB flue is offset to the right

Cost efficient

Two year parts and labour warranty*

Up to 20 metres flue

2
YEAR
WARRANTY

*Subject to registration and an annual service. Terms and conditions apply. Visit www.potterton.co.uk/warranty for more details.

Inside the boiler

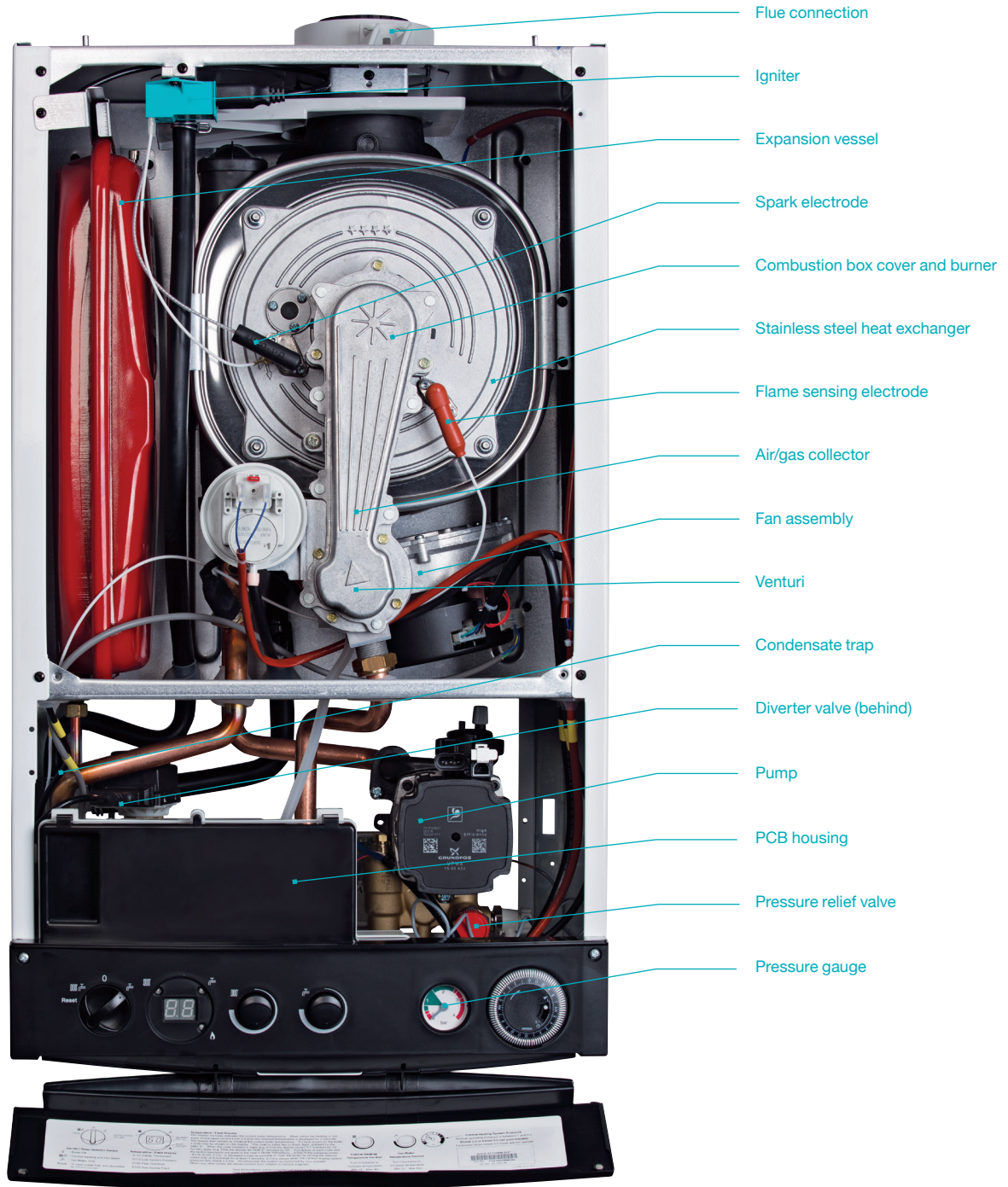

- Flue connection
- Igniter
- Expansion vessel
- Spark electrode
- Combustion box cover and burner
- Stainless steel heat exchanger
- Flame sensing electrode
- Air/gas collector
- Fan assembly
- Venturi
- Condensate trap
- Diverter valve (behind)
- Pump
- PCB housing
- Pressure relief valve
- Pressure gauge

Flues

These are the flues most frequently installed with the Potterton Gold Comb ErP.
For the full range, see pages 28-31.

Horizontal concentric flues Ø 60/100mm

MULTIFIT FLUE GROUP A

Item	Description (multifit) flue system	Colour	Specification	Key and OD dimensions	Sales code
4	Standard horizontal flue inc. low profile elbow and fixing screws*	White pipe/ black terminal	685mm	100mm	7222019
8	1m flue extension inc. fixing screws	White	1000mm	100mm	720648801
11	93° flue bend inc. fixing screws	White	93°	100mm	720648401
13	135° flue bend inc. fixing screws (pair)	White	135°	100mm	720647901

Vertical concentric flues Ø 60/100mm

MULTIFIT FLUE GROUP A

Note - this flue group is ONLY suitable for combi and system appliances

Item	Description (multifit) flue system	Colour	Specification	Key and OD dimensions	Sales code
27	Vertical flue terminal	Black		100mm	5118576
8	1m flue extension inc. fixing screws	White	1000mm	100mm	720648801
11	93° flue bend inc. fixing screws	White	93°	100mm	720648401
13	135° flue bend (pair) inc. fixing screws	White	135°	100mm	720647901
29	Pitched roof flashing		25°/50°	125mm	5122151
30	Flat roof flashing			125mm	246144

Plume displacement kits Ø 60/100mm

MULTIFIT FLUE GROUP A

Item	Description (multifit) flue system	Colour	Specification	Key and OD dimensions	Sales code
16	Plume displacement terminal kit inc. 1m extension and brackets**	White		60mm	720627001
17	Plume displacement kit extension and brackets	White	1000mm	60mm	720643401
18	Plume displacement kit bend	White	93°	60mm	5121369
19	Plume displacement kit bend – pair	White	135°	60mm	5121370
	Plume displacement terminal guard (not shown)	Stainless Steel	100mm	60mm	720644601

*Not compatible with items 16 and 20. **Compatible with item 1.



Potterton Gold System

Reliable construction and high efficiency make this a great, dependable boiler.

Available in 18kW, 24kW and 28kW outputs

Pre-plumbing jig

Flue lengths of up to 20m for flexibility of siting



Adapts output to suit demand	Range of outputs	Energy Saving Trust Endorsed
---	-----------------------------	---

Highest demand

The Potterton Gold System boiler has a choice of outputs to suit homes with even the highest demand for hot water.

A two year parts and labour warranty* gives complete peace of mind for both installer and householder.

Feature	Benefits
Outputs of 18kW, 24kW and 28kW	Suits most property sizes
Fully modulating	Adapts output to suit demand, making it extremely cost efficient to run
Pre-plumbing jig	For easy installation; allows first fix of system pipework, before the boiler is installed
Built-in frost protection	Protects the boiler when installed in unheated garages or utility rooms
Flue lengths up to 20 metres	For great siting flexibility
Two year parts and labour warranty*	For peace of mind
Energy Saving Trust Endorsed	Meets the strictest product and energy performance criteria, and is extremely energy efficient and cost effective

*Subject to registration and an annual service. Terms and conditions apply. Visit www.potterton.co.uk/warranty for more details.

Technical information

The Potterton Gold System is compatible with Flue Group A, G and N

Potterton Gold System		18kW	24kW	28kW
Sales code		7219439	7219440	7219441
Controls				
Concealed user controls		✓	✓	✓
On/off switch with reset		✓	✓	✓
User adjustable CH temperature		✓	✓	✓
LED temp/status/fault diagnosis display		2 digits/3 LEDs	2 digits/3 LEDs	2 digits/3 LEDs
Gas				
Gas supply pipe size	mm	22	22	22
Natural gas		✓	✓	✓
Nominal inlet supply pressure	mbar	20	20	20
Maximum gas rate NG	m ³ hr	1.95	2.61	3.1
Heat Input Central Heating (CH)	kW Max Gross(QnHs)	20.5	27.4	32.1
	kW Min Gross(QnHs)	4.8	7.8	10.8
Heat Output CH non condensing	kW Max (Pn)	18	24	28
	kW min (Pn)	4.2	6.8	9.4
Heat Output CH condensing	kW max (Pnc)	19.4	25.9	30.3
	kW min (Pnc)	4.5	7.5	10.2
SAP 2009 Annual Efficiency (PCDB/SEDBUK)	%	88.6	88.6	88.5
NOx Class		5	5	5
ErP Product Information				
NOx	mg/kWh	29	20	20
Sound Power Level, Indoors	LWA dB	53	58	53
Space Heating Efficiency Class		A	A	A
Electrical				
Electrical supply	Volts/Hz	230/50	230/50	230/50
Permanent live required		✓	✓	✓
Power consumption	watts	105	115	125
External fuse rating	amps	3	3	3
Internal fuse rating		F2L	F2L	F2L
Ingress protection rating		IPX 5D	IPX 5D	IPX 5D
24 hour pump exercise		✓	✓	✓
Pump overrun		✓	✓	✓
Integral 'boiler only' frost thermostat		✓	✓	✓
Mechanical and hydraulic				
Compartment ventilation requirement		None	None	None
Pre-plumbing/wall mounting jig		✓	✓	✓
Flow and return pipe size	mm	22	22	22
Condensate discharge pipe size	mm	21.5	21.5	21.5
Integral automatic bypass		✓	✓	✓
Safety discharge pressure	bar	3	3	3
Integral expansion vessel capacity	litres	8	8	8
Max capacity of central heating system	litres	125	125	125
CH system inhibitor required		✓	✓	✓
Concentric flue systems				
Standard horizontal flue kit length	mm	685	685	685
Max equiv length horizontal/vertical (60/100mm)	m	10	10	10
Max equiv length horizontal/vertical (80/125mm)	m	20	20	20
Equivalent length per 135° bend	m	0.5	0.5	0.5
Equivalent length per 93° bend	m	1	1	1
Twin flue system				
Diameters	mm	80/80	80/80	80/80
Max equiv length horizontal/vertical (parallel pipes)	m	15/15	15/15	15/15
Equivalent length per 135° bend	m	0.25	0.25	0.25
Equivalent length per 91.5° Bend	m	0.5	0.5	0.5
Weights				
Max installation lift weight	kg	36.4	37.9	37.9
Gross packaged boiler weight	kg	41.5	43	43

Technical specification



Dimensions

A width	450mm
B height	780mm
C depth	345mm

Service clearances

D side	5mm
E upper	175mm min
F lower	150mm min
G front	5mm min in operation 450mm for servicing

NB flue is offset to the right

**Cost
efficient**

**Two year
parts and
labour
warranty***

**Up to 20
metres
flue**

**2
YEAR
WARRANTY**

*Subject to registration and an annual service. Terms and conditions apply. Visit www.potterton.co.uk/warranty for more details.

Inside the boiler



Flues

These are the flues most frequently installed with the Potterton Gold System ErP.
For the full range, see pages 28-31.

Horizontal concentric flues Ø 60/100mm

MULTIFIT FLUE GROUP A

Item	Description (multifit) flue system	Colour	Specification	Key and OD dimensions	Sales code
4	Standard horizontal flue inc. low profile elbow and fixing screws*	White pipe/ black terminal	685mm	100mm	7222019
8	1m flue extension inc. fixing screws	White	1000mm	100mm	720648801
11	93° flue bend inc. fixing screws	White	93°	100mm	720648401
13	135° flue bend inc. fixing screws (pair)	White	135°	100mm	720647901

Vertical concentric flues Ø 60/100mm

MULTIFIT FLUE GROUP A

Note - this flue group is ONLY suitable for combi and system appliances

Item	Description (multifit) flue system	Colour	Specification	Key and OD dimensions	Sales code
27	Vertical flue terminal	Black		100mm	5118576
8	1m flue extension inc. fixing screws	White	1000mm	100mm	720648801
11	93° flue bend inc. fixing screws	White	93°	100mm	720648401
13	135° flue bend (pair) inc. fixing screws	White	135°	100mm	720647901
29	Pitched roof flashing		25°/50°	125mm	5122151
30	Flat roof flashing			125mm	246144

Plume displacement kits Ø 60/100mm

MULTIFIT FLUE GROUP A

Item	Description (multifit) flue system	Colour	Specification	Key and OD dimensions	Sales code
16	Plume displacement terminal kit inc. 1m extension and brackets**	White		60mm	720627001
17	Plume displacement kit extension and brackets	White	1000mm	60mm	720643401
18	Plume displacement kit bend	White	93°	60mm	5121369
19	Plume displacement kit bend – pair	White	135°	60mm	5121370
	Plume displacement terminal guard (not shown)	Stainless Steel	100mm	60mm	720644601

*Not compatible with items 16 and 20. **Compatible with item 1.



Potterton Titanium Heat

The lightest boiler available
on the UK market** with no
pump overrun or permanent
live required.

Available in 12kW, 15kW, 18kW,
24kW and 30kW outputs

Only 19.5kg installer lift weight

Easy fit wall mounting bracket

7
YEAR
WARRANTY

A
Efficiency Rating



No pump overrun or permanent live	Front and side access	Lightweight and compact
--	------------------------------	--------------------------------

Compact and lightweight

The Potterton Titanium Heat boiler has a choice of outputs to suit most properties and pockets.

A seven year parts and labour warranty* gives complete peace of mind for both installer and householder.

Feature	Benefits
Outputs of 12kW, 15kW, 18kW, 24kW and 30kW	To suit most property sizes
Only 19.5kg installer lift weight	The lightest boiler available in the UK**
Cupboard fit	Can be installed discreetly
Easy fit wall mounting bracket	Robust with a positive fix and audible lock so you know it's secure
One metre lead included	Easy to install and you don't need access to the control box
Top or rear central flue	For ease of installation
Simple fixing of rear flue	For easy and fail-safe flue fixing
No pump overrun or 'permanent live' required	Saves time and money during installation, and less disruption for the house holder
Wide choice of flue lengths, bends and accessories	For versatile siting

*Subject to registration and an annual service. Terms and conditions apply. Visit www.potterton.co.uk/warranty for more details.
 ** As of March 2017

Technical information

The Potterton Titanium Heat is compatible with flue group A

Potterton Titanium Heat		12kW	15kW	18kW	24kW	30kW
Sales code		7668920	7668922	7668923	7668924	7668925
Controls						
Concealed user controls		✓	✓	✓	✓	✓
Gas						
Gas (Natural Gas/LPG)		NG	NG	NG	NG	NG
Inlet Supply Pressure	mbar	20	20	20	20	20
Maximum gas rate	m ³ /hr	1.42	1.75	2.07	2.73	3.27
Heat Input Central Heating (CH)	kW Max Gross(QnHs)	14.88	18.32	21.75	28.62	34.35
	kW Min Gross(QnHs)	8.59	8.59	8.59	8.59	8.59
Heat Output CH non condensing	kW Max (Pn)	13	16	19	25	30
	kW min (Pnc)	7.5	7.5	7.5	7.5	7.5
Heat Output CH condensing	kW max (Pnc)	12	15	18	24	30
SAP 2009 Annual Efficiency (PCDB/SEDBUK)	%	89.2	89.2	89.2	89.1	89.1
NOx Class		5	5	5	5	5
ErP Product Information						
NOx	mg/kWh	18	20	21	23	24
Sound Power Level, Indoors	LWA dB	32	33	34	35	37
Space Heating Efficiency Class		A	A	A	A	A
Electrical						
Electrical supply	Volts/Hz	230/50	230/50	230/50	230/50	230/50
Permanent live required		✗	✗	✗	✗	✗
Power consumption	watts	17	20	23	33	44
External fuse rating	amps	3	3	3	3	3
Boiler IPX Rating (Electrical Protection)	Approval category	IPX4D	IPX4D	IPX4D	IPX4D	IPX4D
Integral 'boiler only' frost thermostat		✓	✓	✓	✓	✓
Mechanical						
Gas Supply Connection	mm	22	22	22	22	22
Central Heating Connections	mm	22	22	22	22	22
Condensate Drain Connection	mm	21.5	21.5	21.5	21.5	21.5
Upward piping route	mm	✓	✓	✓	✓	✓
Concentric Flue Systems						
Standard telescopic concentric flue length	mm	315 - 500	315 - 500	315 - 500	315 - 500	315 - 500
Horizontal concentric (60/100 mm) - Max equivalent length	mm	6	6	6	6	6
- Reduction per 135° bend	mm	0.5	0.5	0.5	0.5	0.5
- Reduction per 93° bend	mm	1	1	1	1	1
Horizontal concentric (80/125 mm) - Reduction per 93° bend	m	1	1	1	1	1
Weights						
Max installation lift weight	kg	19.5	19.5	19.5	19.5	19.5
Gross Packaged Boiler Weight	kg	21.5	21.5	21.5	21.5	21.5
Packaged Boiler Dimensions (LxWxD)	mm	765 x 427 x 324				

Technical specification



Dimensions

A width	370mm
B height	625mm
C depth	270mm

Service clearances

D side	5mm [†]
E upper	190mm [†] min (35mm [†] if using rear flue)
F lower	120mm [†] min (35mm [†] in 300mm deep wall cupboard)
G front	5mm [†] min in operation 500 [†] mm for servicing

19.5kg lift weight

7 year parts and labour warranty*

Top or rear central flue



[†]These are the minimum recommended dimensions. Greater clearance will aid installation and maintenance.
*Subject to registration and an annual service. Terms and conditions apply.
Visit www.potterton.co.uk/warranty for more details.

Inside the boiler

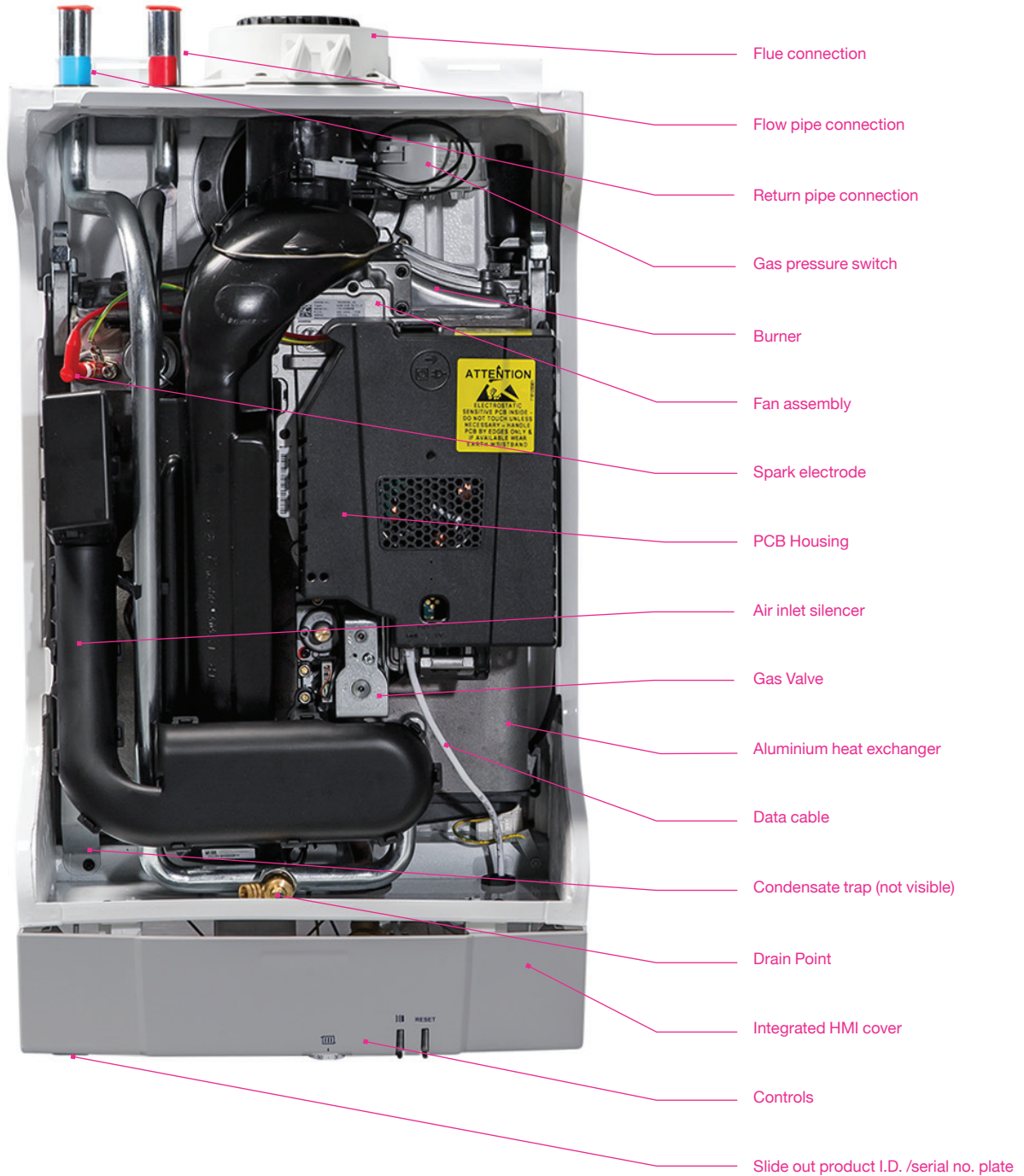

Flues

These are the flues most frequently installed with the Potterton Titanium Heat ErP.
For the full range, see pages 28-31.

Horizontal concentric flues Ø 60/100mm

MULTIFIT FLUE GROUP A

Item	Description (multifit) flue system	Colour	Specification	Key and OD dimensions	Sales code
1	Horizontal telescopic flue inc. low profile elbow and fixing screws	White pipe/ white terminal	315mm – 500mm	100mm	720599401
2	Horizontal telescopic flue inc. low profile elbow and fixing screws	White pipe/ black terminal	315mm – 500mm	100mm	720598701
3	Horizontal telescopic flue inc. Low profile elbow and fixing screws	White pipe/ brown terminal	315mm – 500mm	100mm	720642701
4	Standard horizontal flue inc. low profile elbow and fixing screws*	White pipe/ black terminal	685mm	100mm	7222019
8	1m flue extension inc. fixing screws	White	1000mm	100mm	720648801
11	93° flue bend inc. fixing screws	White	93°	100mm	720648401
13	135° flue bend inc. fixing screws (pair)	White	135°	100mm	720647901

Plume displacement kits Ø 60/100mm

MULTIFIT FLUE GROUP A

Item	Description (multifit) flue system	Colour	Specification	Key and OD dimensions	Sales code
16	Plume displacement terminal kit inc. 1m extension and brackets**	White		60mm	720627001
17	Plume displacement kit extension and brackets	White	1000mm	60mm	720643401
20	Plume displacement terminal kit inc. 1m extension and brackets***	Black		60mm	720622901
21	Plume displacement kit extension and brackets	Black	1000mm	60mm	720643301

Vertical concentric flues Ø 60/100mm

MULTIFIT FLUE GROUP A

Note - this flue group is ONLY suitable for combi and system appliances

Item	Description (multifit) flue system	Colour	Specification	Key and OD dimensions	Sales code
27	Vertical flue terminal	Black		100mm	5118576
8	1m flue extension inc. fixing screws	White	1000mm	100mm	720648801
11	93° flue bend inc. fixing screws	White	93°	100mm	720648401
13	135° flue bend (pair) inc. fixing screws	White	135°	100mm	720647901

*Not compatible with items 16 and 20. **Compatible with item 1. ***Compatible with item 2.

Flue solutions

Our flue kits now come with positive screw fixings for all connections and are available in a choice of lengths to reduce the need for onsite cutting. By popular demand we offer a choice of colours for the terminals to match existing rainwater systems.

Maximum recommended flue lengths

Potterton Combi / System / Store	A (60/100 Concentric)	G (80/125 Concentric)	N (80/80 Twin Pipe)
Horizontal	10	20	15
Vertical	10	20	15
Potterton Heat	B (70/110 Concentric)	P (80/80 Twin Pipe)	
Horizontal	4	75	
Vertical	4	75	

Note - for more information on equivalent flue lengths when using flue bends, please refer to the relevant installation instruction.

Horizontal concentric flues Ø 60/100mm

MULTIFIT FLUE GROUP A

Item	Description (multifit) flue system	Colour	Specification	Key and OD dimensions	Sales code
1	Horizontal telescopic flue inc. low profile elbow and fixing screws	White pipe/ white terminal	315mm – 500mm	100mm	720599401
2	Horizontal telescopic flue inc. low profile elbow and fixing screws	White pipe/ black terminal	315mm – 500mm	100mm	720598701
3	Horizontal telescopic flue inc. Low profile elbow and fixing screws	White pipe/ brown terminal	315mm – 500mm	100mm	720642701
4	Standard horizontal flue inc. low profile elbow and fixing screws*	White pipe/ black terminal	685mm	100mm	7222019
5	Flue terminal deflector	White		60mm	720644201
6	Flue terminal deflector	Black		60mm	5111068
7	Flue terminal deflector	Brown		60mm	720644301
8	1m flue extension inc. fixing screws	White	1000mm	100mm	720648801
9	0.5m flue extension inc. fixing screws	White	500mm	100mm	720643001
10	0.25m flue extension inc. fixing screws	White	250mm	100mm	720643101
11	93° flue bend inc. fixing screws	White	93°	100mm	720648401
12	135° flue bend inc. fixing screws	White	135°	100mm	720648501
13	135° flue bend inc. fixing screws (pair)	White	135°	100mm	720647901
14	Offset adaptor elbow	White		100mm	720635501
15	Stainless steel terminal guard – Ø 60/100	S/S	Stainless steel	100mm	720627901

Plume displacement kits Ø 60/100mm

MULTIFIT FLUE GROUP A

Item	Description (multifit) flue system	Colour	Specification	Key and OD dimensions	Sales code
16	Plume displacement terminal kit inc. 1m extension and brackets**	White		60mm	720627001
17	Plume displacement kit extension and brackets	White	1000mm	60mm	720643401
18	Plume displacement kit bend	White	93°	60mm	5121369
19	Plume displacement kit bend – pair	White	135°	60mm	5121370
20	Plume displacement terminal kit inc. 1m extension and brackets***	Black		60mm	720622901
21	Plume displacement kit extension and brackets	Black	1000mm	60mm	720643301
22	Plume displacement kit bend	Black	93°	60mm	720648701
23	Plume displacement kit bend – pair	Black		60mm	720648601
	Plume displacement terminal guard (not shown)	Stainless Steel	100mm	60mm	720644601
24	Under balcony eaves flue kit	White		60mm	7211039
25	Under balcony eaves flue kit	Black		60mm	7211041

*Not compatible with items 16 and 20. **Compatible with item 1. ***Compatible with item 2.

Vertical concentric flues Ø 60/100mm

MULTIFIT FLUE GROUP A

Note - this flue group is ONLY suitable for combi and system appliances

Item	Description (multifit) flue system	Colour	Specification	Key and OD dimensions	Sales code
26	Vertical ridge flue terminal	Brown		100mm	720647101
27	Vertical flue terminal	Black		100mm	5118576
28	Roof cover plate			125mm	246143
8	1m flue extension inc. fixing screws	White	1000mm	100mm	720648801
9	0.5m flue extension inc. fixing screws	White	500mm	100mm	720643001
10	0.25m flue extension inc. fixing screws	White	250mm	100mm	720643101
11	93° flue bend inc. fixing screws	White	93°	100mm	720648401
12	135° flue bend inc. fixing screws	White	135°	100mm	720648501
13	135° flue bend (pair) inc. fixing screws	White	135°	100mm	720647901
29	Pitched roof flashing		25°/50°	125mm	5122151
30	Flat roof flashing			125mm	246144



Titanium and Gold Range guide

Flue solutions

Horizontal concentric flues Ø 80/125mm

MULTIFIT FLUE GROUP G

Item	Description (multifit) flue system	Colour	Specification	Key and OD dimensions	Sales code
31	Horizontal flue inc. boiler and terminal adaptors	Black		125mm	5118580
32	1m flue extension	White	1000mm	125mm	5118584
33	Flue bend	White	91.5°	125mm	5118588
34	Flue bend (pair)	White	135°	125mm	5118597
35	Pipe support bracket	White	125mm flue pipe	125mm	5118610

Vertical concentric flues Ø 80/125mm

MULTIFIT FLUE GROUP G

Item	Description (multifit) flue system	Colour	Specification	Key and OD dimensions	Sales code
36	Vertical flue terminal	Black		125mm	5111078
32	1m flue extension	White	1000mm	125mm	5118584
33	Flue bend	White	91.5°	125mm	5118588
34	Flue bend (pair)	White	135°	125mm	5118597
28	Roof cover plate			125mm	246143
37	Flue vertical adaptor	White		100/125mm	5111070
29	Pitched roof flashing		25°/55°	125mm	5122151
30	Flat roof flashing			125mm	246144
35	Pipe support bracket	White	125mm flue pipe	125mm	5118610



Twin pipe flues 80/80mm

MULTIFIT FLUE GROUP N

Note - this flue group is ONLY suitable for combi and system appliances

Item	Description (multifit) flue system	Colour	Specification	Key and OD dimensions	Sales code
36	Vertical flue terminal	Black		125mm	5111078
38	Twin pipe extension (pair inc. Brackets)	White	1000mm	80mm	5111087
39	Twin pipe flue bend (pair)	White	90°	80mm	5111072
40	Twin pipe flue bend (pair)	White	135°	80mm	5111086
28	Roof cover plate			125mm	246143
41	Twin pipe flue horizontal terminal kit (air and exhaust)	Stainless steel		80mm	5120172
42	Twin pipe flue adaptor (boiler)	White		80/80mm	720089801
43	Twin pipe support (pair)	White		80mm	5111081
44	Twin to concentric adaptor 80/80 - 80/125	White		80/125mm	5111084
29	Pitched roof flashing		25°/50°	125mm	5122151
30	Flat roof flashing			125mm	246144
45	Pitch roof flue terminal	Black	25°/50°	60mm	720576301
46	Pitched roof terminal adaptor kit	White		60-80mm	5121792
47	Single flue terminal (air only)			80mm	5121791

Terminal position with minimum distance

	(mm)
A ¹ Directly below an opening, air brick, opening windows etc	300
B ¹ Above an opening, air brick, opening window etc	300
C ¹ Horizontally to an opening, air brick, opening window etc	300
D ² Below gutters, soil pipes or drain pipes	25
E ² Below eaves	25
F ² Below balconies or car port roof	25
G ² From a vertical drain pipe or soil pipe	25
H ² From an internal or external corner	25
I Above ground, roof or balcony level	300
J From a surface or boundary line facing a terminal	600
K From a terminal facing a terminal (Horizontal flue)	1200
K From a terminal facing a terminal (Vertical flue)	600
L From an opening in a carport (e.g. door, window) into the dwelling	1200
M Vertically from a terminal on the same wall	1500
N Horizontally from a terminal on the same wall	300
R From adjacent wall to flue (vertical only)	300
S From an adjacent opening window (vertical only)	300
T Adjacent to windows or openings on pitched and flat roofs	600
U Below windows or openings on pitched roofs	2000

- In addition, the terminal should be no nearer than 150mm to an opening in the building fabric formed for the purpose of accommodating a built-in element such as a window frame.
- Only ONE 25mm clearance is allowed per installation. If one of the dimensions D, E, F, G or H is 25mm then the remainder MUST be as B.S.5440-1.

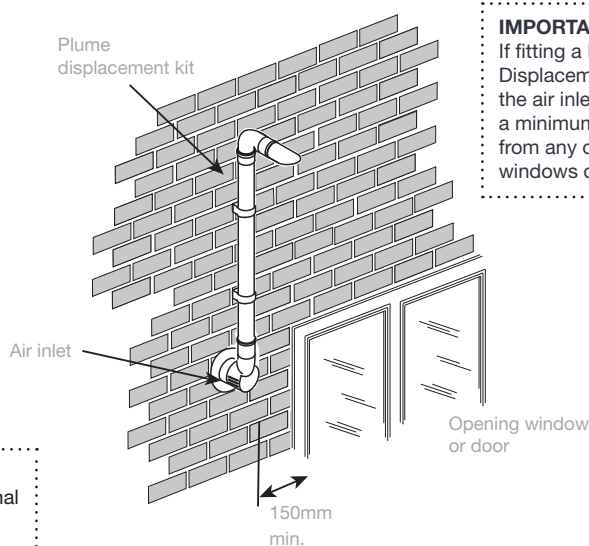
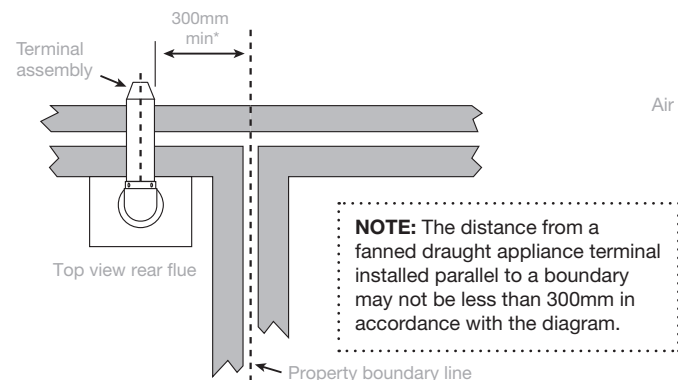
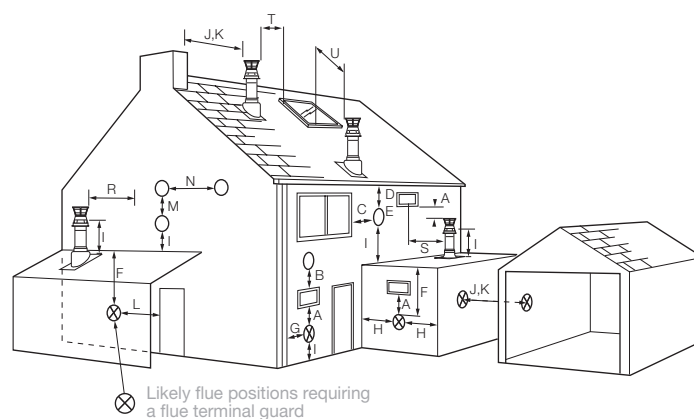

*This can be reduced to 25mm by using item 6/7/8 flue deflector.

Support you can depend on

Potterton is part of Baxi, meaning it benefits from our extensive customer support services. Whatever you need, our expert support is never more than a phone call away.



Customer support

We will provide expert support, whenever you need it, for the lifetime of the boiler.

- UK customer contact centre
- Nationwide network of Gas Safe registered engineers
- Technical helpline provides expert technical support and advice

Call: 0344 871 1545



Genuine parts

Baxi Genuine Parts offers an extensive range of components, consumables, safety devices and tools.

We can provide all the parts you need for installation, maintenance and annual servicing.

- Available through a nationwide network of approved stockists
- Lifetime support for Potterton products
- Parts available for 10 years after cessation of boiler

Find a genuine part or your nearest stockist: baxigenuineparts.co.uk



Training

We run courses at training centres throughout the UK.

Our expert trainers will tailor the courses to suit your individual requirements, so you can install, service and maintain Potterton boilers with confidence.

- Free of charge hands-on product training
- Expert trainers, all accredited, experienced former heating engineers
- Training centres across the UK

To book your place on a Potterton training course call: 0344 848 8281



Baxi Works

Sign up to **Baxi Works**, Baxi's online loyalty scheme for installers. Benefits include:

- Same or next day engineer call out from Baxi Customer Support*
- Free Gas Safe notification and easy warranty registration
- Scan your barcodes using the Baxi Toolbelt App
- Free annual service reminders sent to your customers on your behalf
- Free listing on baxi.co.uk to receive homeowner leads
- Earn points for every boiler you register

Visit baxiworks.co.uk to find out more

Carbon Monoxide

Safety is our highest priority, so we recommend the use of an audible carbon monoxide alarm whenever you install a boiler, or other carbon burning appliance.

- Make sure it is marked with British Standard EN 50291 and the Kitemark
- Fitting a carbon monoxide alarm is not a substitute for an annual service

*Full Works terms and conditions apply

POTTERTON

Brooks House
Coventry Road
Warwick
CV34 4LL

Customer support
0344 871 1545

www.potterton.co.uk



This brochure is printed on paper sourced from well managed forests and other controlled sources. This brochure is printed using vegetable based inks. Please recycle this brochure when you have finished with it.

Baxi policy is one of continual improvement and development. The right to change specification and appearance without prior notice is reserved. The reproduction of colours is as accurate as photographic and printing processes allow. The consumer's statutory rights are not affected. e&oe

TGRG_ISSUE1_03/17

part of **BAXI**