

F127

QUALITY ACTIVE HEAT CONVECTOR
WITH USER-FRIENDLY CONTROLS



All electrical appliances produced for the Company are guaranteed for one year against faulty material or workmanship. This applies only if the appliance has been used for purposes in accordance with the instructions provided and has not been connected to an unsuitable electricity supply, or subject to misuse, neglect, damage or modified or repaired by any person not authorised by the Company. This guarantee is offered to you as an extra benefit and does not affect your legal rights. The correct electricity supply voltage is shown on the rating label attached to the appliance. Reasonable care has been taken to ensure that this guide is accurate at the time of printing. In the interest of progress the Company reserve the right to vary specifications from time to time without notice.

Caution



Attention :
Surface très
chaude
Caution
hot surface

Caution very hot surface.

CAUTION: Portions of this product may become hot and cause burns. Pay particular attention to the presence of children and vulnerable people.

- Keep away from this unit child under 3 years unless they are under continuous surveillance.
- Children between 3 and 8 years should only put the unit on or off, to provided that the latter has been placed or installed in a normal position and that these children have supervision or have received instructions on using the machine safely and understand the potential hazards. Children aged between 3 and 8 years must not connect or adjust or clean the device and perform maintenance or user .
- This unit can be used by older children at least 8 years and by people with physical, sensory or mental capabilities or lack of experience or knowledge , they (if) is monitored correctly (s) or instructions for using the appliance safely given to them and if the risks were apprehended. Children should not play with the appliance . Cleaning and maintenance by the user should not be performed by children without supervision.
- This device must be plugged or connected according to the rules and standards applicable by an authorized person.
- The instruction book of this product is available by contacting the after-sales service with the number indicate on the warranty part included in this manual service.
- Do not use the appliance if the power cable is damaged.

	Caution: to avoid overheating and for safety reasons, do not cover the panel heater.
	Devices with this symbol should not be disposed with household waste but must be collected separately and recycled. The collection and recycling of end of life must be made according to the provisions and local ordinances (DEEE 2002/96/CE).
	The installation of the device in high altitude causes an increase of the temperature air outlet (about 10 ° C per 1000 m elevation).

INSTALLATION

Where to install your device?

- This equipment was designed to be installed in a residence. Please ask your distributor before using it for any other purpose.
- The device should be installed according to normal trade practice and in compliance with legislation in the relevant country (NFC 15-100 for France).
- The equipment is class 2 and is protected against splashed water IP 24. The device can be installed in volume 2 of a bathroom. It's forbidden to install the device in the volume I. The device is to be installed so that switches and other controls cannot be touched by a person in the bath or shower.

Do not install the device :

- In a draught that might affect adjustment (for example, under a central mechanical ventilation unit etc...).
- Under a fixed power socket or near curtains or other combustible materials.
- In a conform position, the air outlet grid and the control unit is visible in the upper part of the device. It is forbidden to install a vertical unit horizontally and vice versa.

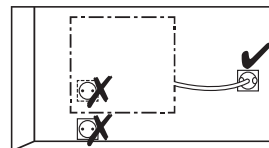
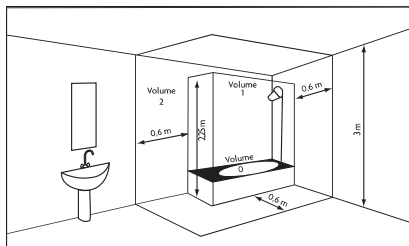

Volume I No electrical device

Volume 2 Class II IPX4 electrical device
(Norme EN 60335-2-43 : 2003/A2 : 2008)

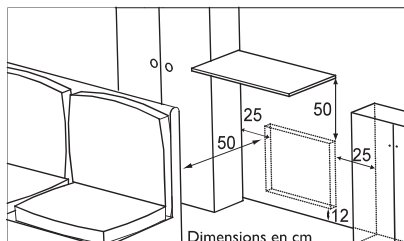

Comply with the minimum clearance distances for positioning of the device.
Do not install a shelf above vertical devices.

INSTALLATION

Release the appliance's hook-on bracket

We recommend that you place the panel heater flat, face down.

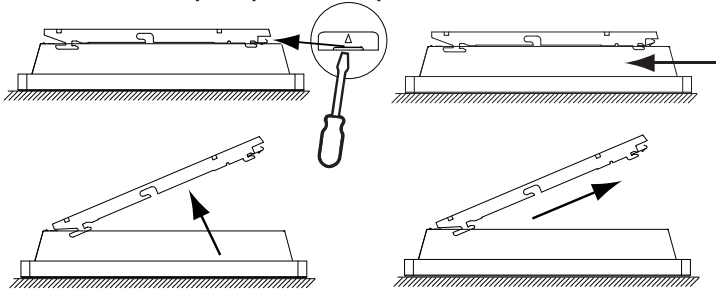

Fix the hook-on bracket

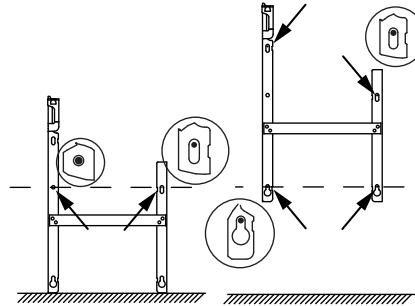

ELECTRICAL CONNEXION

Connection device - device with pilot wire

- The device should have a 220/230V 50/60Hz power supply.
- The device's power supply must be directly connected to the main supply after the circuit breaker without any intermediate switch.
- The device's power cable must be connected to the main supply via a connection box. In damp areas, such as bathrooms and kitchens, the connection box must be installed at least 25cm above the floor.
- An Earth connection is prohibited. **Do not connect the pilot wire (black wire) to Earth.**
- Power must be directly connected to the grid after pole disconnection device in accordance with the installation requirements.
- If the power cable is damaged, it must only be replaced by an electrician.
- If you are using the pilot wire and it is protected by a 30mA differential (e.g.: bathroom use), the pilot wire's power supply must also be protected on this differential.

Wiring diagram for the device

- Cut off the power supply and connect the wires as shown in the following diagram:

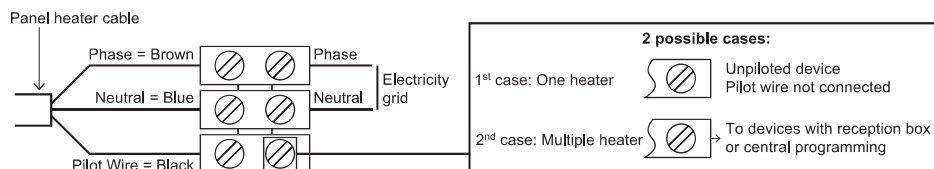

Commands Received	No current	Complete alternation 230 V	Negative Half/alternation - 115V	Positive Half/alternation + 115V
Oscilloscope Ref/Neutral	—			
Mode obtained	COMFORT	ECO	ANTI - FREEZE	STOP HEATING LOAD SHEDDING

Connection device - device with plug

WARNING: devices with plugs can not be installed on the French market.

WALL MOUNTED INSTALLATION

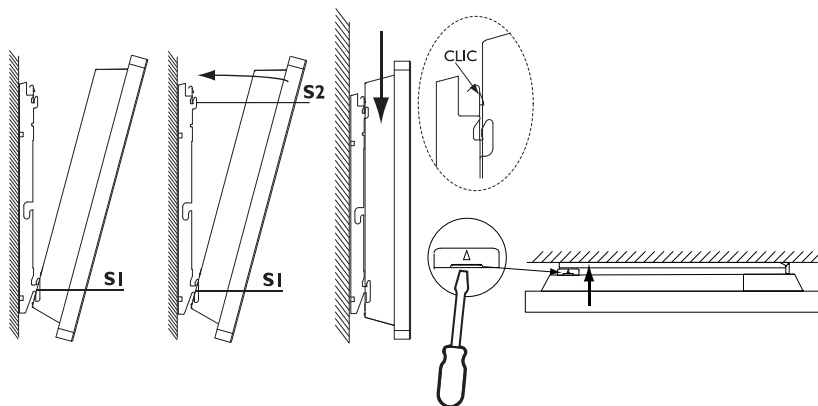

MAINTENANCE

To retain the performance of the device, it is necessary about twice a year to carry out dust removal using a vacuum cleaner or a brush at the air inlets and outlets. Every five years, have the inside of the device checked by a professional electrician. The outside of the device can be cleaned with a damp cloth.

Never use abrasive products or solvents.

OPERATING PRINCIPAL

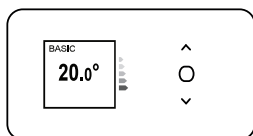

- Increase or reduce the temperature without needing to validate.



- Browsing in the menus:



- Validate;
- Switch off;
- Lock, unlock.

DESCRIPTION OF THE MODES

2 operating modes are proposed:

BASIC

The appliance follows the setpoint temperature adjusted at all times.

PROG

- The appliance follows the internal program defined for each day of the week. The following ranges are defined when the appliance is switched on:

Monday to Friday, comfort from 5am to 9am and from 5pm to 11pm

Saturday and Sunday, comfort from 5am to 11pm.

You may modify these ranges and define 3 Comfort temperature ranges per day.

During these Comfort ranges, the temperature setpoint is adjusted using \wedge or \vee .

Outside the Comfort ranges, lowering the temperature is set in "Lower ECOT°" Prog mode (see *chapter "The menu in PROG mode"*).

-The appliance follows your installation's external programming orders (see *the manual for your programming unit*).

THE SWITCH

An On/Off switch is located at the rear of the device's unit.

Use the switch for extended shutdowns only

(excluding heating periods).

Set the switch (located at the rear of the appliance) to to switch the appliance on. When the appliance is switched off, you may need to set the day and time again.

SWITCHING THE APPLIANCE ON FOR THE FIRST TIME

Select the language, then the date and time.

The first time you switch the appliance on,

-PROG mode is selected,

-the setpoint temperature is set at 19° C.

SWITCHING THE APPLIANCE ON / OFF



To shut down the appliance, press and hold .

Confirm "Switch off" by pressing .

To switch the appliance on, press and hold .

LOCKING COMMANDS

To avoid the commands being changed by children, you may lock your appliance's commands by pressing and holding .

Select "Lock"  and validate with .

Do the same to unlock the commands by selecting "Unlock" .

WINDOW OPEN FUNCTION

Used to detect variations in temperature related to the opening and closing of your windows.

If you forget to switch off your appliance when a window is open for a long time, this function lets you get around this and prevents your appliance from heating up unnecessarily.

The appliance automatically switches to Frost Protection mode (7°C) when it detects an open window and rises to the setpoint temperature when it detects that the window has been closed (the detection time is variable).

We do not recommend using this function in corridors and rooms located near an entry door which opens to the outside.

ADJUSTING THE TEMPERATURE

Use the consumption indicator to optimize your setting. When the consumption indicator is at the level of the green symbol, the temperature is lower or equal to the recommended temperature.



In BASIC mode:



- Increase with \wedge (max 28°C).
- Lower with \vee (min 12°C).
- Reduce again to 7°C (Frost Protection temperature not modifiable) with \vee .

In PROG mode:

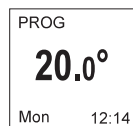

- If the screen displays PROG, you are in a programming range in Comfort mode.
- Increase with \wedge (max 28°C).
 - Lower with \vee (min 12°C).

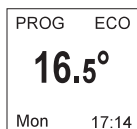

If the screen displays ECO PROG, you are in a programming range in ECO mode.

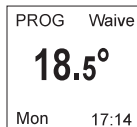

You can change the ECO temperature, so you have to set the default setting between the Comfort temperature and the Eco temperature. “PROG Derog” is displayed until the next Comfort range.

You can set the difference between the Comfort and Eco temperature in the “Abase” menu. T ° ECO “.

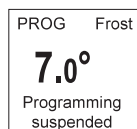

If you set a Frost Protection temperature (7°C), the programming is suspended. Modify this temperature when you return to restart the programming.

Remote control of the operating modes and programs of the device is possible with the Cozytouch application available on App Store® or Google Play®.

The following accessories are required:

- A Cozytouch Bridge (to be installed on your Internet box)
- One Cozytouch Interface per device.

The menu in BASIC mode

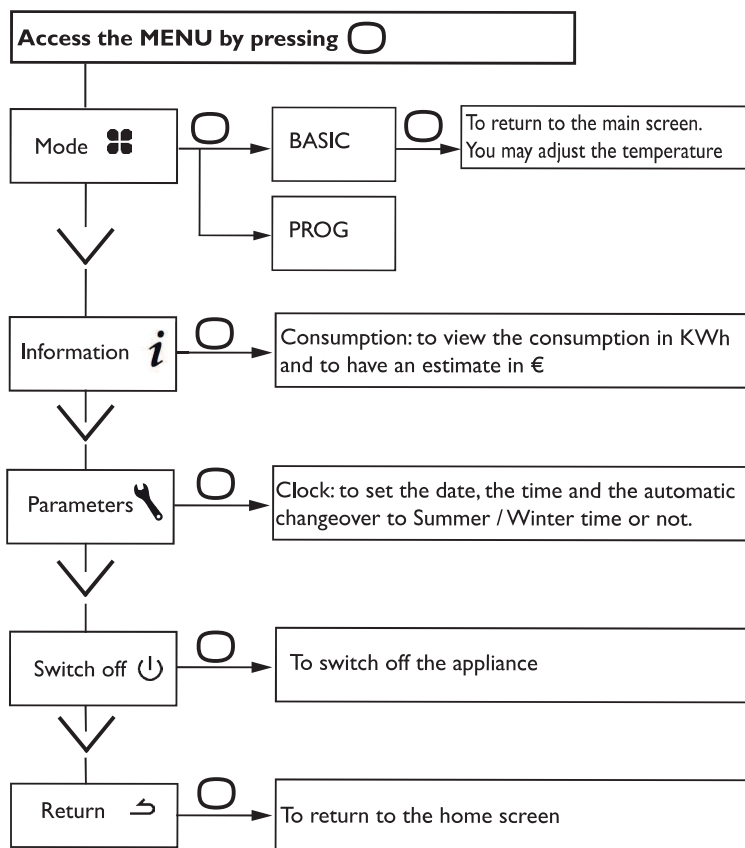

The menu in PROG mode

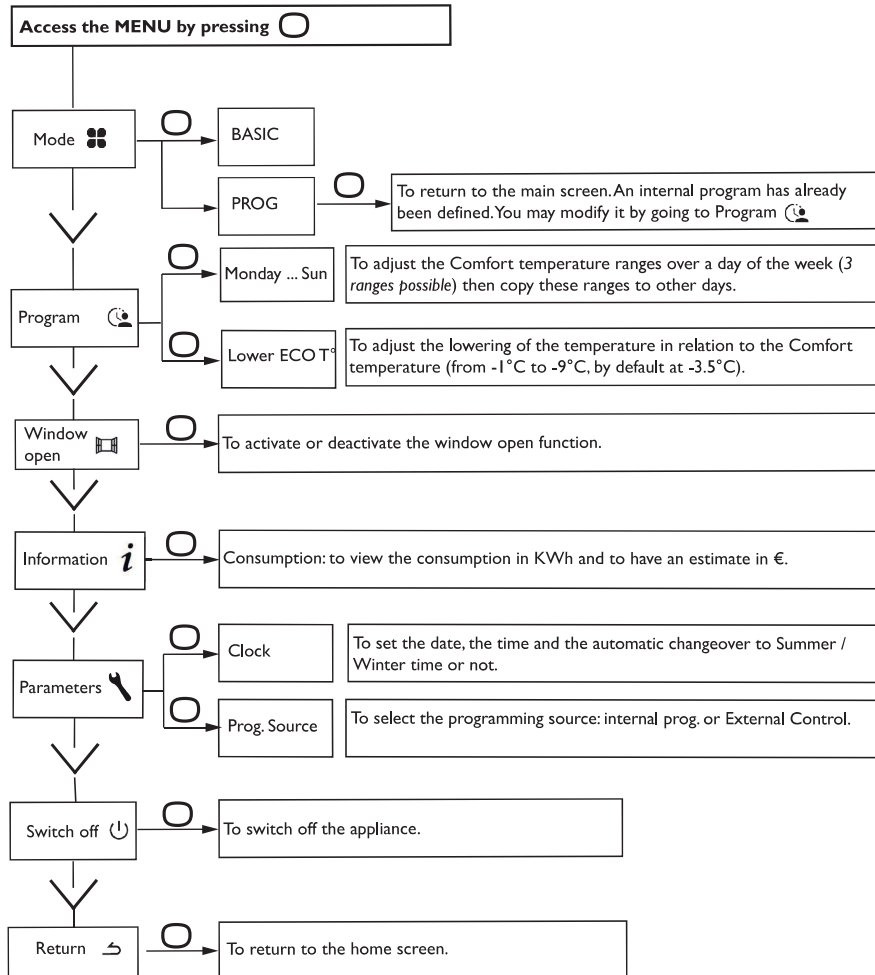

USING INTERNAL PROGRAMMING

MODIFYING THE PROGRAMS

You may program up to 3 Comfort temperature ranges for each day of the week. Outside the Comfort ranges, lowering the temperature is set in "Lower ECO T°" Prog mode (see chapter "The menu in PROG mode").

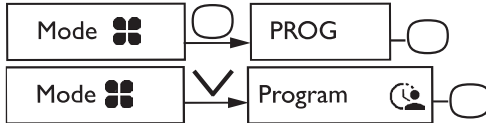

Select the day with \wedge . Validate .

Select . Validate .

Select the start time with \wedge or \vee . Validate . Select the end time with \wedge or \vee . Validate .

COPYING A PROGRAM

You may copy a day's program to one or more days.

Select . Validate .

Scroll through the days with \wedge or \vee . Validate the day to copy the program with .

To validate the copy, select "Copy". Validate .

Lundi	
<input checked="" type="radio"/> Mar	<input checked="" type="radio"/> Ven
<input type="radio"/> Mer	<input type="radio"/> Sam
<input checked="" type="radio"/> Jeu	<input type="radio"/> Dim
Copier	

Example: Program copy from Monday to Tuesday, Thursday, Friday.

DELETING A COMFORT TEMPERATURE RANGE

Select the day with \wedge . Confirm .

Select . Confirm .

On the starting time, select 0:00 with \vee . Confirm . On the ending time, select also 0:00 with \vee and confirm .

USING EXTERNAL PROGRAMMING

The appliance follows the external control of your installation via pilot wire link.

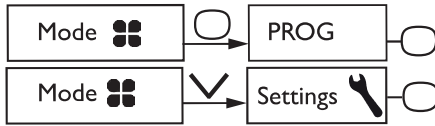

Select Source prog. with \checkmark . Confirm \bigcirc .

Choose Ext. control with ∇ and confirm \bigcirc .



The EXPERT menu

To access the appliance's advanced functions, press \bigcirc and \wedge at the same time for over 3 seconds.

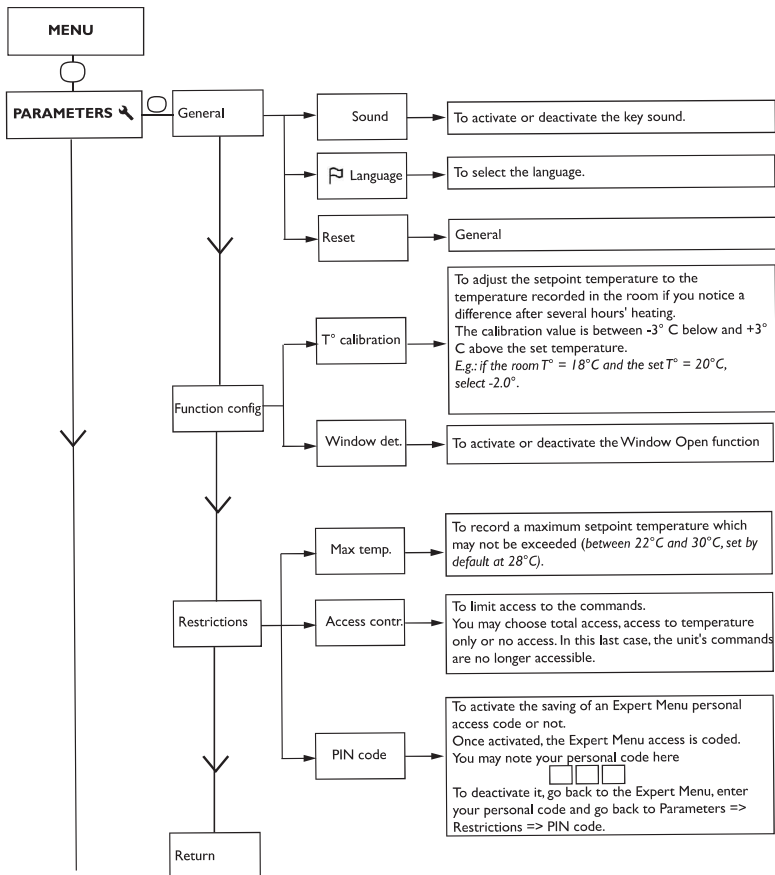

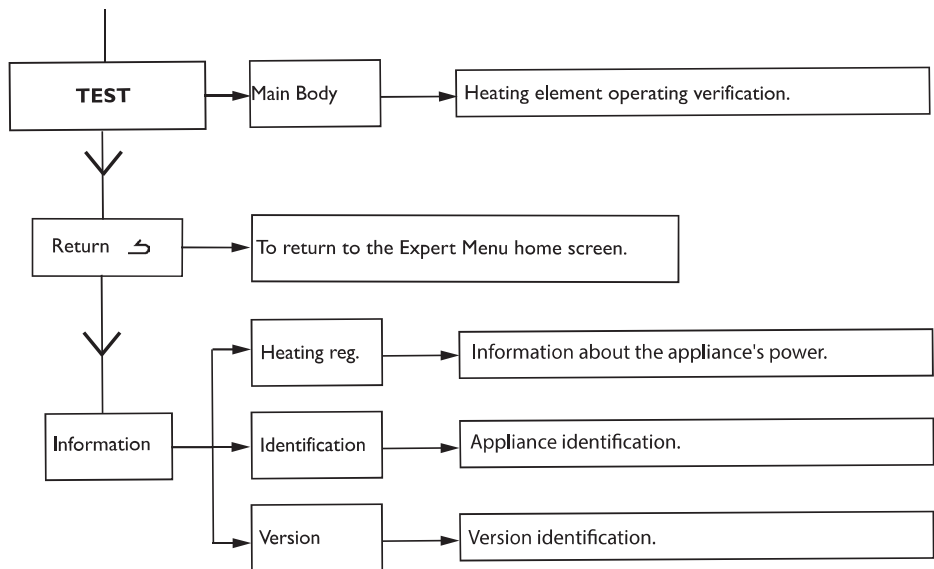

Trouble Shooting

Problems	Check
The screen of the control panel does not turn on.	Make sure the switch on the back or on the side of the device is in position I. Make sure the device is connected to the electrical system.
The device is not heating.	If the device is in programming mode, make sure the programming is set at COMFORT. Make sure the circuit breakers of the system are activated or that the load shedder (if you have one) did not out powered the heater. If the temperature of the room is higher than the set temperature, it is normal the device is not heating.
The device is heating all the time.	Make sure the device is not located near an air stream or the set temperature was not increased.
The device is not heating enough.	Increase the Comfort set temperature. If it is set at the maximum temerature, check the following: - Check if another heating mode exists in the room. - Make sure your device is only heating the room (closed door). - Have the power supply to the device checked. - Check if the power of your device is adapted to the size of your room (we recommend an average of 100 W/m ² for a ceiling height of 2,50m or 40W/m ³).
The surface of the device is very hot.	It is normal for the device to be hot when in use.The maximum surface temperature is limited according to the NF Electricity Performance Standard. However, if you feel that your device is still too hot, make sure the power is adapted to the size of your room (we recommend 100W/m ² for a ceiling height of 2,50m or 40W/m ³) and that the device is not placed near an air stream which would affect its control mechanism.
Dirty marks appear on the wall around the device.	The dirty marks come from the bad quality of the air in the room. In this case, you are advised to check that the room is correctly aired (<i>ventilation, vent duct, etc.</i>), that the air is clean and not to smoke in the room. Your device will not be replaced under guarantee because of these dirty marks.
The Expert Menu is not accessible.	You saved a PIN. You must enter your PIN to access the Expert Menu (see Expert menu section). If you forgot your PIN, enter the code 081.
The device does not follow internal programming commands.	Check the set date and time. Make sure the device is in PROG MODE and internal programming is selected.
The device does not follow external programming commands.	Make sure the programming unit is used properly (see the operating instructions of the Control Unit). Make sure the device is in PROG MODE and the external control is selected.

If you were not able to solve your problem, contact a professional with your device references found on the nameplate (*commercial code (C), serial No. (E)*), room temperature and maybe the programming system references. You may also have to provide information contained in the Information Part of the Expert Menu.

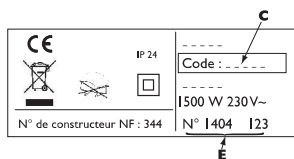

Warranty conditions

- The guarantee period is two years from the date of installation or purchase and may not exceed 30 months from the date of manufacture in the absence of a receipt.
- The guarantee covers the replacement and supply of components recognised as being defective, excluding any damages or interest.
- The user is responsible for any labour or transport costs.
- The guarantee does not cover any damage arising from improper installation, abnormal use or non-observance of the requirements of the said instructions for installation and use .
- The stipulations of the present guarantee conditions do not exclude any of the purchaser's legal rights of guarantee against faults or hidden defects, which are applicable in all cases under the stipulations of Articles 1641 of the Civil Code.
- Present this certificate to your distributor or installer only in the event of a claim, together with your purchase invoice.

The commercial code and the serial number identify for the manufacturer the particular device you have bought.

This information can be found on the information plate situated on the side of the device.

To claim under guarantee, contact your installer or dealer. If necessary, contact :

ATLANTIC INTERNATIONAL

58 Av Gén. Leclerc

92340 Bourg-La-Reine

France Tel: (33) 146836000 Fax: (33) 146836001

Characteristic

Model references		F127		
Characteristic	Symbol	Value	Unit	
Heat output				
Rated heat output	P nom	0,5 to 2 500 to 2000	kW W	
Minimum heat output	P min	0,5 500	kW W	
Maximum continuous heat output	P max,c	2 2000	kW W	
Auxiliary electricity consumption				
At rated heat output	el max	0.000	kW	
At minimum heat output	el min	0.000	kW	
In standby mode	el sb	0,00048 0,48	kW W	
Type of heat output / room temperature check				
Characteristic	Unit	Additional information		
Electronic room temperature check and weekly programmer	yes			
Other inspection options				
Room temperature check, with presence detector.	no			
Room temperature check, with open window detector.	yes			
Remote control option.	yes			
Adaptive activation control.	yes			
Activation time limiter.	no			
Black globe sensor.	no			
Contact details	Idem information label			



atlantic-heat.co.uk

T: 0844 3350 549 F: 0844 5436 180
E: enquiries@atlantic-heat.co.uk
Atlantic Heat | PO Box 103, National Avenue,
Kingston Upon Hull, HU5 4JN

Atlantic Heat is part of Ideal Boilers Limited. Ideal Boilers Ltd. pursues a policy of continuing improvement in the design and performance of its products. The right is therefore reserved to vary specification without notice.

**GROUPE
ATLANTIC**
UK, ROI & NORTH AMERICA DIVISIONS