

EV-RV15A Contract 15mm angled valves

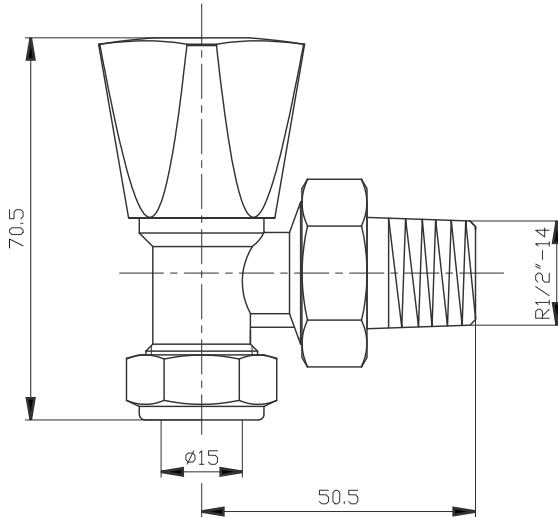

Specifications

Medium: Water

Maximum Working Pressure: 10 Bar

Maximum Pressure Differential: 1 BAR

Minimum Water Temperature: 2 °C

Maximum Water Temperature: 100 °C

Maximum Ambient Temperature: 50 °C

Material

- Valve body made of chrome-plated CW614N brass
- Valve insert made of CW614N brass with EPDM seals
- Tailpiece and union-nut made of chrome-plated brass
- Wheel handle and lockshield cap made of ABS

